

Packing Instructions

For delivery at



Logistics location	Delivery times
<p>Jobarco B.V. Verbreepark 15 NL-2731 BR Benthuisen</p>	<p>Ma.-Vri. 08:00 - 15:00 uur verzoekaanlogistiek@jobarco.com</p>
<p>Pantaflex B.V. Verbreepark 2A NL-2731 BR Benthuisen</p>	<p>Ma.-Vri. 08:00 - 15:00 uur verzoekaanlogistiek@pantaflex.nl</p>

1. Delivery on Euro pallets

The delivery of the goods only takes place on pallets suitable for high-bay storage and suitable for automatic conveyor technology.

Drums in sizes 400 to 800 mm are to be delivered exclusively on Euro pallets with the dimensions 1200 x 800 x 144 mm.

Technical data:

Length:	1200 mm
Width:	800 mm
Total height:	144 mm
Entry height:	100 mm
Deadweight:	28-32 kg
Permitted gross weight:	1.000 kg
Floor space:	0,96 m ²

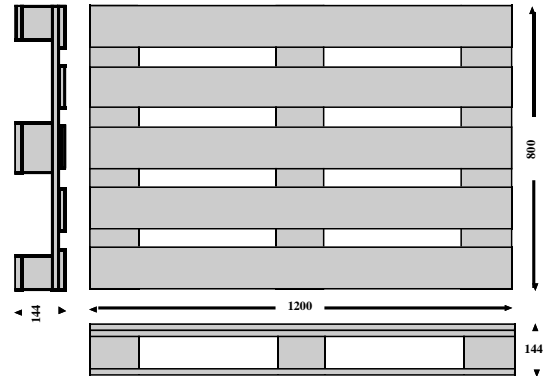

Euro pallet (pool pallet DIN 15 146, sheet 2, standard dimension and DIN 15 147, UIC 435-2 - NEW or class A).

The pool flat pallet with a loading area of 800 x 1200 mm is a four-way pallet, i.e. it can be picked up from all sides without any obstacles. It complies in all parts with the DIN standards and the requirements of the European Pallet Pool.

Condition of the Euro pallet suitable for high-bay storage

Euro pallets are **unusable** if:

- A board is missing, broken diagonally or crosswise.
- Floor and ceiling edge boards are splintered in such a way that two or more nail and screw shafts are visible on one board or one or more shafts are visible on more than two boards.
- A block is missing, broken or splintered in such a way that more than one nail or screw shank is visible.
- Obviously unacceptable components have been used for the repair (e.g. boards or blocks that are too thin, too narrow, too short).
- The general condition is so bad that the load-bearing capacity is no longer guaranteed (rotten or several splintered boards or blocks).
- The dampness is so great that weathering is visible or labels cannot adhere to the pallet.



Keine fehlenden Klötze !

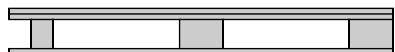

Kein unzulässiges Bauteil verwenden!

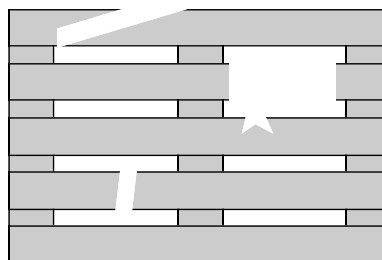

Keine Bruchstellen !

Loading the Euro pallets

For better handling, only drums of the same size may be used per pallet. An edge protector must be fitted to the drum to protect the goods.

In principle, overhanging on the pallet is not accepted. All pallets must be packed flush.

Excess or short lengths must be delivered on a separate pallet.

Drums 400 mm

Maximum one layer of drums with plastic flange

Maximum two layers of drums with wooden or plywood flange Height 450 mm

Maximum three layers of drums with wooden or plywood flange Height 300 mm

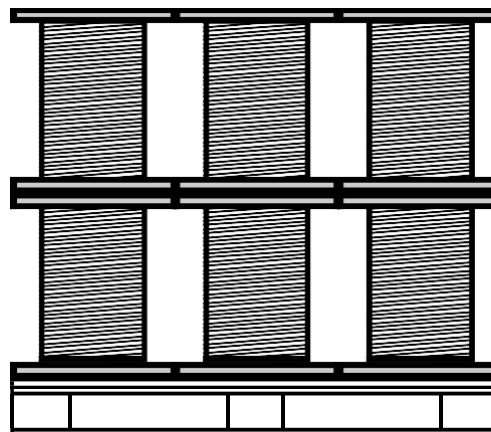
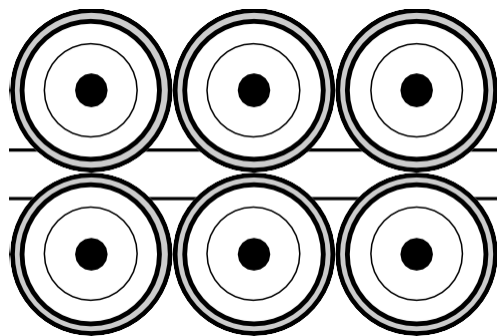

Drums 500 mm

Maximum one layer of drums with plastic flange

Maximum two layers of drums with wooden or plywood flange Height 470 mm

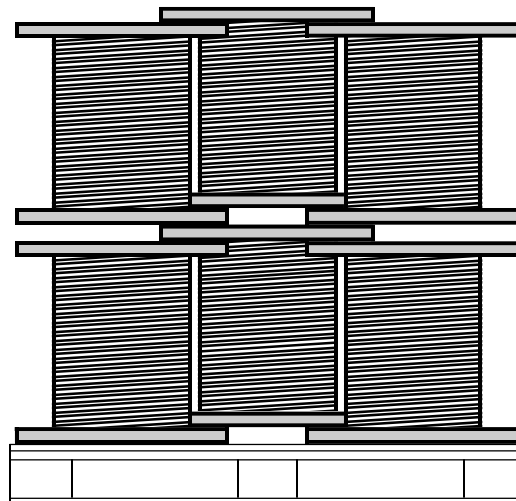
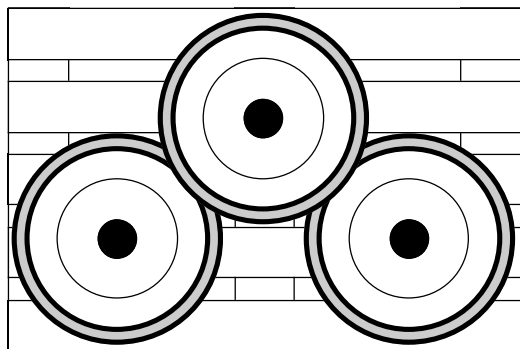

Drums 600 mm

Maximum one layer of drums with plastic flange

Maximum two layers of drums with wooden or plywood flange Height 520 mm

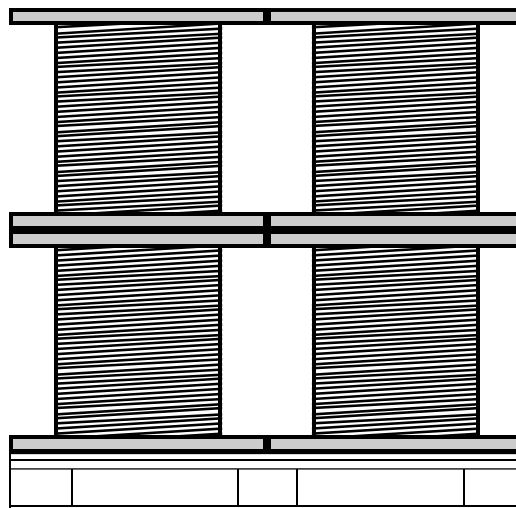
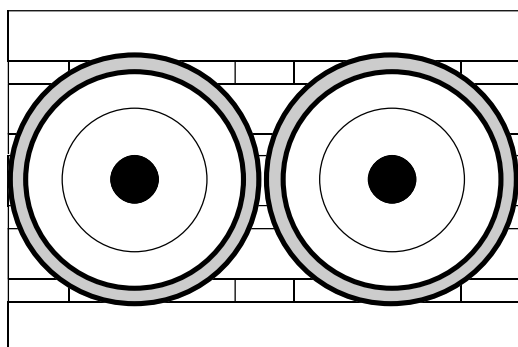

Drums 700 mm

secured with two squared timbers fixed to the Euro pallet

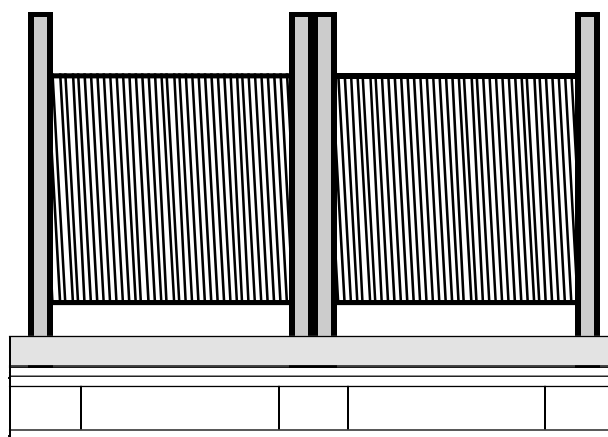
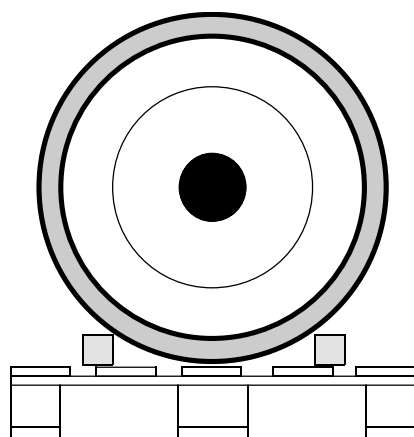

Drums 800 mm

Two drums standing on the flanges next to each other
Secured with two squared timbers fixed to the Euro pallet

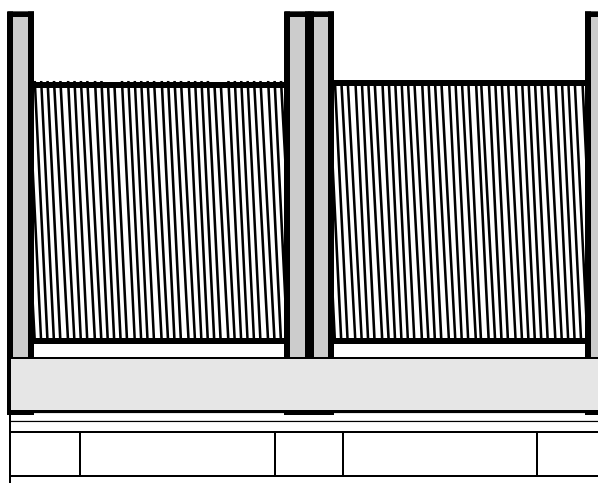
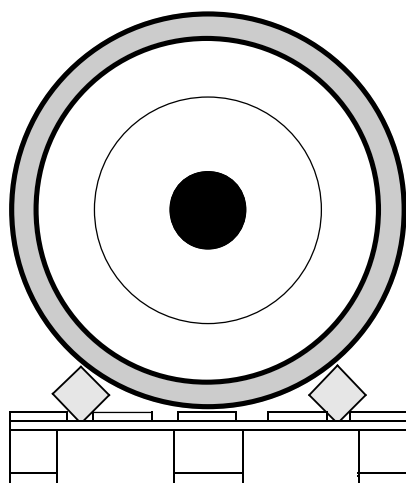

When delivering to our location in NL-Benthuizen, it is permitted to deliver 800 mm drums stacked twice on top of each other on one-way pallets (size 800 x 800 mm).

Barrels

Standing next to each other

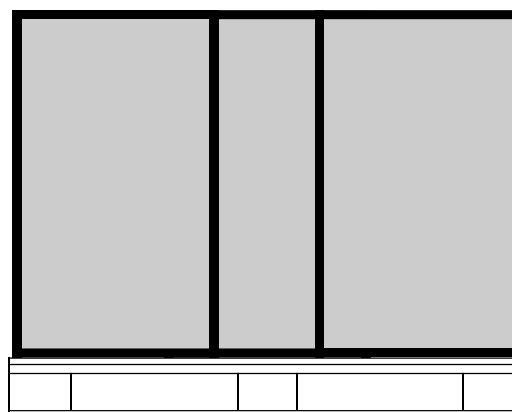
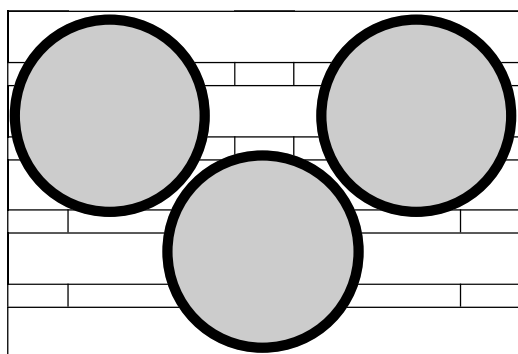

Single core boxes

Maximum height 900 mm, with half cargo the dimension is reduced to 550 mm.
Do not stack pallets with single core cartons several times on top of each other.
If necessary, use intermediate layers of cardboard / plywood to stabilize the single-wire cartons.

Mixed pallets should be avoided or, if necessary, adequately marked.
Pallets must be packed flush, without overlap.

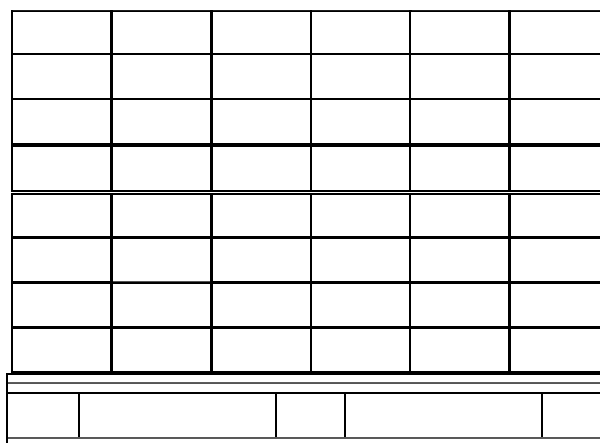
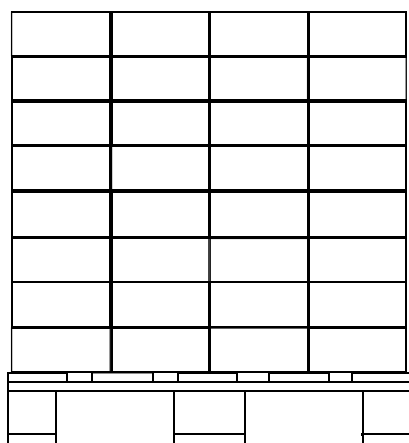

Rings

Maximum height 900 mm, with half stock the dimension is reduced to 550 mm.

A cardboard box or a layer of packing paper must be inserted between the pallet and the first layer of rings to protect the ring goods.

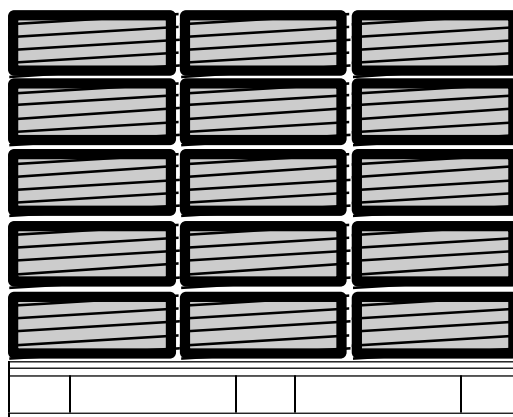
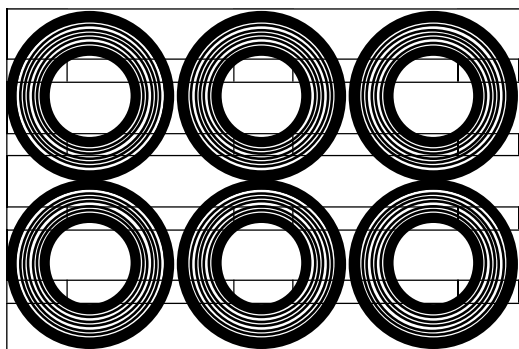

2. Delivery of Drums

- Since the pallet dimensions are exceeded from drum size 900 mm, these drums must be delivered loosely upright without pallets or stacked horizontally with or without pallets.
- The maximum drum size is 1800 mm and the maximum weight must not exceed 2500 kg.
- Drums larger than 1800 mm must always be delivered standing up.
- All drums larger than 1800 mm up to a maximum weight of 5000kg must be registered separately

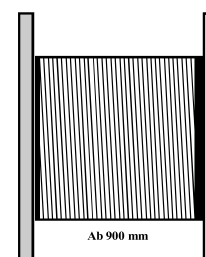

Condition of the drums from size 900 mm

Drums

- Weatherproof, forklift-compatible wood quality with sufficient load-bearing capacity, no pressed material.
- In principle, drums treated according to ISPM No. 15 are to be delivered, exceptions only upon consultation with the responsible purchaser,
- The load capacity of the drum flanges must correspond to the total weight of the full drum. The drum flanges must be suitable for forklift handling.
- The minimum core diameters depend on the respective requirements with regard to the bending radii of the cables and lines to be supplied.
- The axle mounting hole must be 40 - 90 mm.
- No screws or connecting parts may protrude beyond the outer drum dimensions.

Wrapping

- Intermediate layer of neutral, environmentally friendly film or similar suitable materials between drum core and winding material. No advertising media permitted!
- Drum wrapping up to a maximum distance of 80 mm from the flange edge.
- Sufficient ground clearance must be ensured.
- Drums must be wrapped in transparent film.

Cable ends

- Both cable ends must be exposed and freely accessible for testing. Length approx. 150 mm.
- The cable ends must be sealed moisture-proof with end caps. Securing of the cable ends with staples on the drum flange, cord or with packaging foil.

3. Maximum loading height

When delivering goods on Euro pallets, please note that the maximum loading height of 1200 mm incl. Euro pallet must not be exceeded.

4. Labelling

The labels on the individual packages must be applied in a way that they can be easily read from the outside on the Euro pallet.

All cables that have UL and/or CSA approval must bear UL and/or CSA labels sufficient for the length. These must be attached to the reel flange or the carton so that they are clearly visible - not on the packaging wrapping

5. Securing the load

- The goods must be secured against slipping on the Euro pallet with stretch film.
- Do not wrap stretch film over the fork shaft of the Euro pallet.
- The drum goods can alternatively be secured with tension straps (possibly with a wooden lid).
- For drums, single core cartons and rings in film, place a layer of corrugated cardboard between the Euro pallet and the packages.
- When stacking Euro pallets, suitable securing devices such as wooden frames or cardboard spacers must be used to prevent damage to the goods on the lower Euro pallet due to pressure or rubbing.
- The goods must be loaded in such a way that they reach the recipient undamaged and in perfect condition.
- The loading area of the vehicle must have sufficient load-bearing capacity.

6. Notification

Notification is made by the supplier before the goods are handed over to the delivery partner. Please note that deliveries to CCG must always be notified to the recipient of the goods (delivery address).

Please notify shipments of 5 pallets or more by e-mail:

Jobarco B.V.: verzoekaanlogistiek@jobarco.com

Pantaflex B.V.: verzoekaanlogistiek@pantaflex.nl

Generally, the following data must be provided: Supplier, the delivery company you have commissioned, number of Euro pallets and number of drums, the possible date of dispatch and a description of the items with the order number. The listing of the articles can be replaced by an enclosed packing list, delivery notes, etc. ...

Deliveries with a volume of more than 5 pallets must always be scheduled by

Jobarco / Pantaflex.

The goods will only be dispatched after we have confirmed your notification. In the confirmation, you will then also be given the planned arrival date. The goods must always be delivered packed on Euro pallet in accordance with our packaging instructions. Drums up to 120 cm horizontally must always be delivered on a pallet. All drums larger than 120 cm must be delivered (if delivery on a pallet is not possible) in consultation with Benthuzen (verzoekaanlogistiek@jobarco.com or verzoekaanlogistiek@pantaflex.com).

7. Unloading

In principle, it is only possible to unload the vehicle from the back via a ramp by means of a forklift truck or pallet truck. Unloading from the side of the vehicle is not possible. The following applies in deviation from this: drums weighing 2500 kg or more are exceptional cases, must be registered separately and must be prepared for unloading from the side. (See also page 9)

We would also like to draw your attention to our delivery times Mon - Fri. Please note the times of the respective delivery location according to the information on page 1.

We expressly declare the refusal of acceptance and unloading in case of non-observance of these regulations! We declare that any additional costs incurred will be recharged!

Regulations for the loading of the delivering trucks

As all suppliers know, trucks are unloaded at the ramp from the back when they are delivered, and this is done exclusively by forklift truck - only in exceptional cases by pallet truck.

Therefore, each truck must be loaded in such a way that industrial trucks can enter and lift off the load without hindrance.

The condition of the Euro pallets used is also important here, which must not be defective or wet!

Correct:

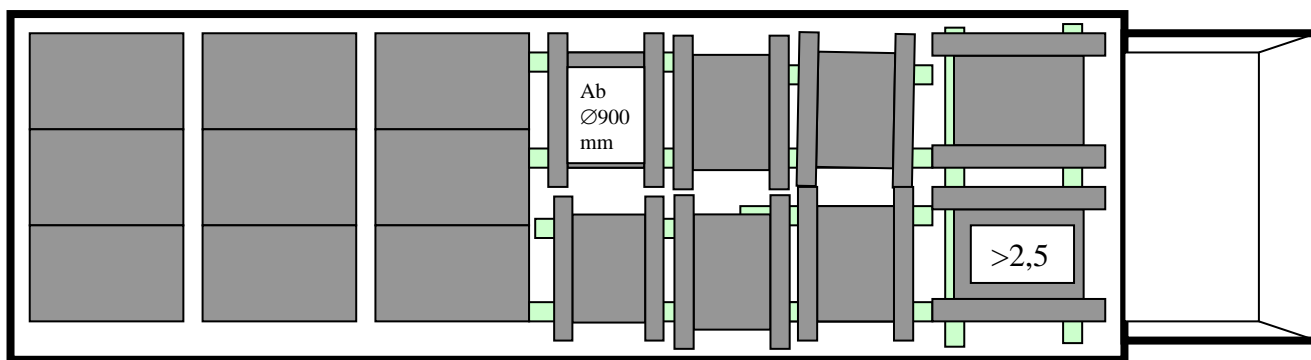

Drums (from size 900mm) up to 2.5 tonnes must be loaded transversely to the direction of travel, drums over 2.5 tonnes must be loaded lengthwise to the direction of travel and be ready to be unloaded from the side. In this case, it is absolutely necessary to notify us of the weight!

Beams are not disposed of and unloaded on our part, alternatively tension belts can be used. Do not use dump trailers without their own crane!

Wrong:

